

**HYPERMOTARD**





## Index

4	Play time. Show time.	28	Servicing and maintenance
6	Supermoto style	30	Technical data and equipment
9	Game on! Level SP.	40	Apparel
14	Game on. Level up	46	Accessories. Configure the Ducati of your dreams.
17	Ducati Testastretta 11°	52	Ducati Digital Experience
18	A chassis that screams fun		
25	Advanced electronics		
27	Your next destination. Your first Ducati.		

## Play time. Show time.

For the 2022 range, Ducati ensures the Hypermotard 950 family is Euro 5 compliant and presents a new livery for the SP version. This update guarantees the same torque and power values.

A new colourway that recalls the racing world in its tones and the world of freestyle sports in its graphics highlights the bike's youthful character.

The ideal choice for those seeking sheer excitement when riding as well as maximum fun, without compromising on safety.

The Hypermotard 950, Hypermotard 950 RVE and Hypermotard 950 SP models are perfect whether riding the bends or weaving through city traffic, thanks to their advanced performance and sophisticated electronics package.



## Supermoto style



The clean line and narrow volumes of the Hypermotard 950 reveal its sports roots, while the 14.5 litre tank recalls that of a supermoto race bike. The aggressive look, with its simple, stretched shapes and surfaces, is accentuated with double

silencers under the tail, a pared-back fairing, and the iconic front section, a distinctive trait of every Hypermotard model. Viewed from the front, the single headlight with Daytime Running Light (DRL) makes a real impact,

giving the Hypermotard 950 a modern, technological appearance that is unmistakable, even during the day.





## Game on! Level SP.

The new Hypermotard 960 SP livery recalls the world of MotoGP in its tones and the world of freestyle sports in its graphics, giving the bike a strong, dynamic character. The dedicated sports livery revolves around the double under-seat exhaust and reduced superstructures, which make for visible mechanics. This includes the rear trellis sub-frame, which communicates that light, sleek supermoto style.

The Öhlins suspension with increased stroke comprises a 48 mm front fork and rear shock, both fully adjustable and able to guarantee a lean angle of 47° (3° more than the Hypermotard 950). And the bike is even more 'track ready' with the Ducati Quick Shift (DQS) up/down EVO, Marchesini forged three-spoke wheels and Pirelli Diablo Supercorsa SP tyres.





## Game on. Level up



The "Graffiti" graphics on the 950 RVE version emphasise the bike's lightness and aggression with a high-impact design inspired by urban graffiti. For the first time across such an extensive, complex surface, Ducati has utilised ultra-thin waterslide decals

during the painting phase. The application process is particularly lengthy and complicated and calls for highly specialised skills. The end result is comparable to that of airbrushed bodywork in terms of both its aesthetics and texture.





## Ducati Testastretta 11°

The Hypermotard 950 mounts the latest evolution Ducati 937 cc Testastretta 11° engine, Euro 5 compliant and delivering overall power of up to 114 HP at 9000 rpm. Torque reaches a peak of 9.8 Kgm at 7250 rpm and traces a flat curve that ensures strong and continuous drive. 80% of the torque is already available at 3000 rpm and this rises to 88% between 5000 and 9500 rpm.

The Testastretta 11° is driven by a new 53 mm throttle body and is regulated by an engine control unit and a new Ride-by-Wire throttle command designed to offer smooth, easy to manage delivery.

The Hypermotard 950 twin also boasts magnesium clutch and alternator covers, a more lightweight clutch drum, an aluminium belt tensioner, magnesium head covers, and a wet slipper clutch with hydraulic control.

The gearbox has been revised to facilitate shifting into neutral when the bike is stationary and to ensure maximum precision when selecting the gears.

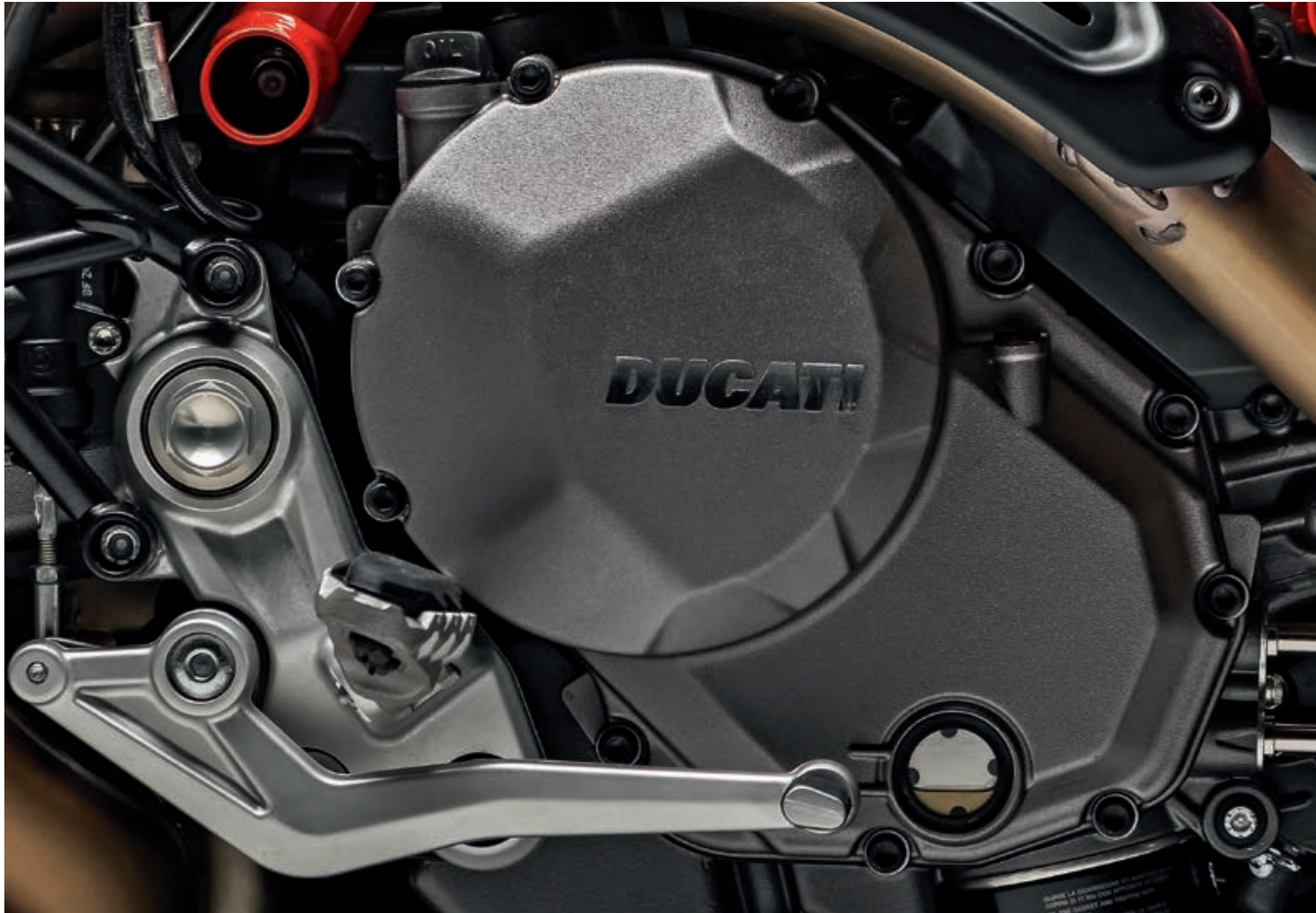

## A chassis that screams fun

The chassis of the Hypermotard 950 is designed to offer maximum enjoyment and control.

The bike's ergonomics ensure an erect riding position and wide elbows, which translates into significant vehicle control, agility when changing direction, and stability through the turns. The flat seat allows for significant longitudinal movement.

The steel trellis frame with variable-section tubes, the steering column with 25° angle and the 104 mm of trail with 30 mm offset ensure stable, safe control, while the 1493 mm wheel base (1498 mm for the SP version) guarantees stability even at high speeds.

The rear sub-frame is particularly tapered where it connects to the main frame, allowing for a seat that is narrow in the hip area, so that the rider can more easily reach the ground with both feet.

The variable-section aluminium handlebar serves to support the radial master cylinders with separate brake/clutch fluid reservoirs, controlled with adjustable levers. And the suspension adds to the adrenaline rush, with a fully adjustable 45 mm Marzocchi front fork with aluminium inner and outer tubes and 170 mm travel, and an adjustable Sachs single shock with 150 mm travel at the rear.

The SP version offers even more high-performance supermoto-style riding thanks to its Öhlins suspension with increased stroke (+ 15 mm at the front, + 25 mm at the rear).

The front incorporates a pair of Brembo four-piston M4.32 monobloc radial callipers that act on 320 mm discs with light aluminium flanges, while the rear features a single Brembo calliper acting on a single 245 mm disc.







## Advanced electronics

The Hypermotard 950 boasts modern and advanced electronics based on the use of the 6-axis inertial platform that can immediately identify bike roll, yaw and pitch.

The electronics package include: Bosch ABS Cornering with Slide by Brake function, Ducati Traction Control (DTC) EVO, Ducati Wheelie Control (DWC) EVO and Ducati Quick Shift (DQS) up/down EVO, available as an accessory, or as standard on the RVE and SP versions.

The Hypermotard 950 comes with three pre-defined Riding Modes - Sport, Touring and Urban.

The rider can customise their riding style and restore the parameters set by Ducati.

**Sport.** For sports riding on the road, track or through the turns, the system exploits the full 114 HP of the Ducati twin associated with a performance-oriented electronics set-up.

**Touring.** Ideal for urban and out-of-town trips and for those who prefer a clean, smooth ride. The 114 HP of the Ducati twin are delivered according to a more safety-oriented electronic set-up.

**Urban.** In conditions of poor grip, the Testastretta 11° twin is limited to 75 HP while the electronic settings ensure maximum safety.

Instrumentation on the Hypermotard 950 comprises a 4.3" TFT display with graphics and interface inspired by those of the Panigale V4. With informative graphics for each system, the rider can more easily navigate the menus and immediately identify the selected Riding Mode and adjust the settings.





## Your next destination. Your first Ducati.

Ducati has a wide range of models for all riders, whatever their experience level.

Your new licence unlocks the door to the world of motorcycling; make a real entrance with the Hypermotard. Enjoy the fun, the performance, and the technology right away with the 35kW reduced-power version, perfect for your A2 licence.

New licence holders can also experience all the fun, performance and technology of the new Hypermotard, with a **35kW reduced power version to suit the A2 licence.**

Contact your dealer for more information or visit [www.ducati.com](http://www.ducati.com)



# Servicing and maintenance

## Safety as standard

The continuous work that Ducati carries out in terms of design, research and development serves to ensure cutting edge bikes characterised by maximum active safety levels. A commitment that involves the definition of increasingly advanced technological systems to increase the rider's level of control, such as the Ducati Safety Pack (DSP) that, for Hypermotard 950, includes ABS Bosch Cornering EVO and Ducati Traction Control (DTC). Equipment that optimises the bike's dynamic performance in both braking and acceleration and that offers numerous levels of adjustment with three different intervention levels for the Cornering ABS and eight for the Ducati Traction Control (DTC).

## More value to your passion

With Ever Red, the quality and reliability of the Ducati brand remain your inseparable travelling companions over time. Ever Red is the exclusive Ducati warranty extension programme. With its activation you can continue to feel protected for 12 or 24 months beyond the expiration of the Ducati Warranty (24 months). Ever Red includes roadside assistance for the entire coverage period and no mileage limits. In this way you can ride for all the kilometres you want, even abroad, enjoying your Ducati without any worries.

To find out if the Ever Red extension is available in your country and for further information contact your Ducati dealer or visit [ducati.com](http://ducati.com).

## Endless excitement

In designing each bike, Ducati constantly strives to ensure maximum reliability while reducing service costs. A commitment that has seen the intervals for the main Desmo Service, in which valve clearance is checked and adjusted if necessary, to be extended to 30,000 km for the Hypermotard 950.

Even the simplest of checks, such as the Oil Service, are extended to 15,000 km or 12 months. A considerable interval for such high performance engines, which only confirms the high quality standards adopted in terms of material selection and R&D processes. Ducati continuously invests in the technical training of its dealers.

The specific skills offered by the official Ducati Service network ensure that all those operations needed to keep every Ducati in perfect condition are thoroughly executed, while advanced equipment such as the Ducati Diagnosis System allows the software on each Ducati to be updated with the latest releases, ensuring that the electronics continue to perform at the maximum level.

## Always by your side

One of Ducati's main goals is to offer every Ducatista the chance to enjoy unlimited and safe travel all over the world. To achieve this aim, Ducati offers a "fast delivery" original spares service, with delivery in 24/48 hours across 85% of the areas in which it operates. With a distribution network that covers more than 91 countries, thanks to 738 official Dealers and Service Points\*, choosing a Ducati means you can travel worry free and in total freedom, wherever the road may take you, and count on support from our extensive Dealer network that ensures Ducati quality and professionalism is always close at hand.

**738** Authorised dealers and service points

**91** World countries

\*information - last update 31 December 2020.



**Ever Red**  
Extended Warranty



\*Equal to 18,000 miles.



## Technical data and equipment





# HYPERMOTARD 950

## Dimensions

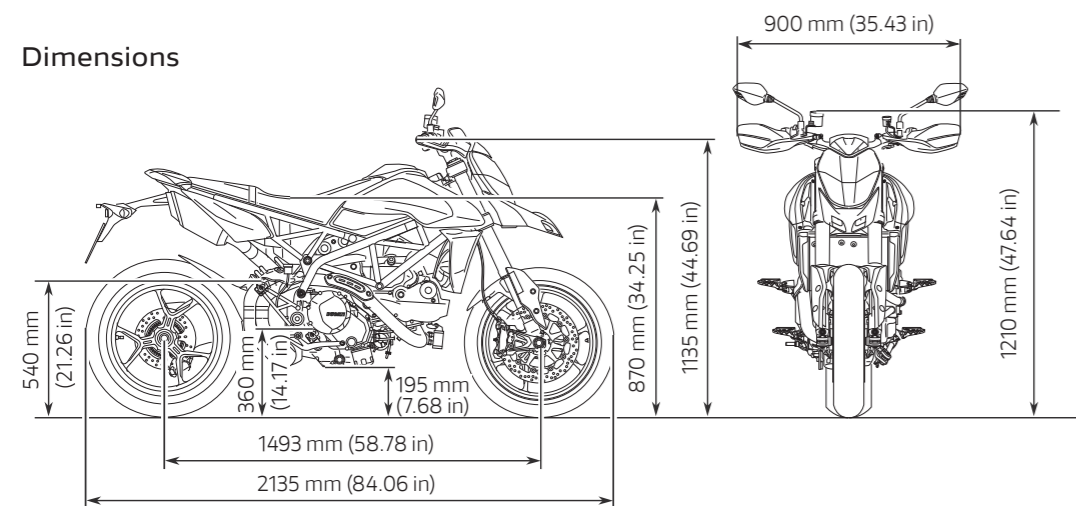

## Power and torque

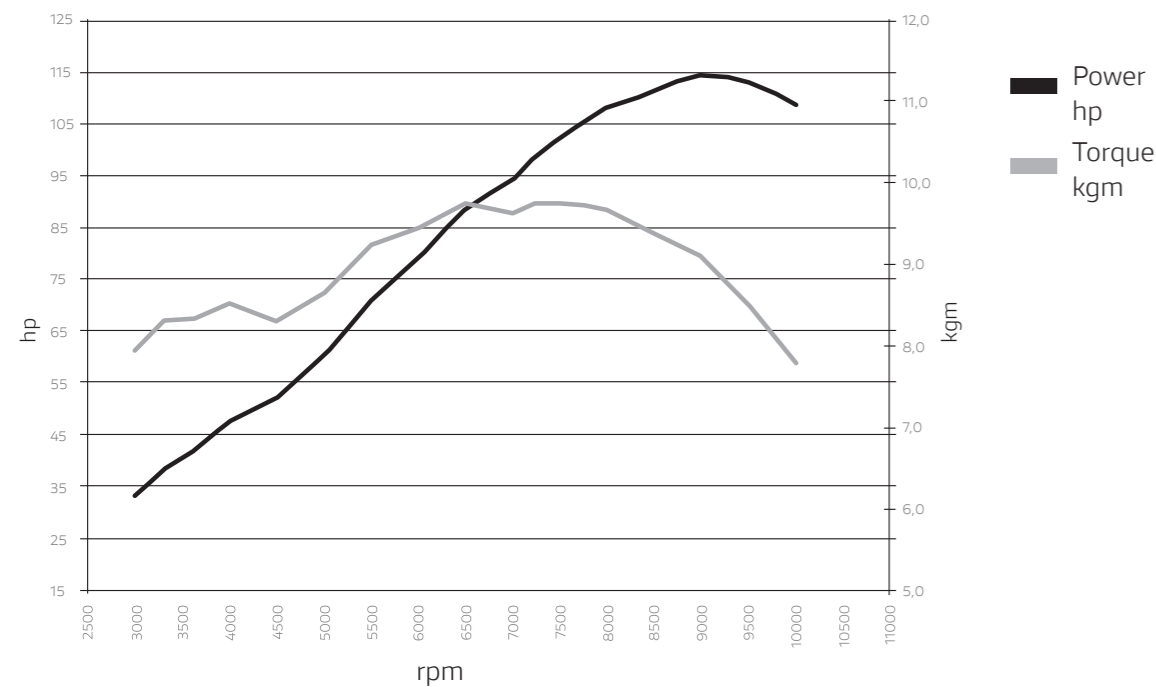

## Engine

**Engine** Testastretta 11°, L-Twin cylinder, 4 valve per cylinder, Desmodromic, liquid cooled, magnesium head covers, hydraulic clutch command

**Displacement** 937 cc

**Bore X stroke** 94 x 67,5 mm (3,70 x 2,66 in)

**Compression ratio** 13,3:1

**Maximum power** 114 hp (84 kW) @ 9.000 rpm

**Maximum torque** 71 lb-ft (96 Nm) @ 7.250 rpm

**Fuel injection** Electronic fuel injection system, Ø 53 mm throttle bodies with full Ride by Wire system

**Exhaust** Double under-tail aluminum muffler; catalytic converter and two lambda probes.

## Transmission

**Gearbox** 6 speed

**Primary drive** Straight cut gears; Ratio 1.85:1

**Ratio** 1=37/15 2=30/17 3=28/20  
4=26/22 5=24/23 6=23/24

**Final drive** Chain; Front sprocket 15; Rear sprocket 43

**Clutch** Slipper and self-servo wet multiplate clutch, hydraulic control

## Chassis

**Frame** Tubular steel Trellis frame

**Front suspension** Marzocchi aluminum fully adjustable, upside-down Ø 45 mm

**Front wheel** Y shaped 3-spoke light alloy 3.5" x 17"

**Front tyre** Pirelli Diablo Rosso III, 120/70 ZR17

**Rear suspension** Progressive linkage with adjustable spring preload and rebound damping Sachs monoshock. Aluminium single-sided swingarm

**Rear wheel** Y shaped 3-spoke light alloy 5.5" x 17"

**Rear tyre** Pirelli Diablo Rosso III, 180/55 ZR17

**Wheel travel (front/rear)** 170 mm (6.7 in) - 150 mm (5.9 in)

**Front brake** 2 x Ø 320 mm semi-floating aluminum flange discs, radially mounted Monobloc Brembo callipers, 4-piston 2-pad, radial pump with adjustable lever, with ABS Bosch Cornering

**Rear brake** Ø 245 mm disc, 2-piston calliper, with ABS Bosch Cornering

**Instrumentation** Full-TFT color display

## Dimensions and Weights

**Dry weight** 178 kg (392 lb)

**Kerb weight** 200 kg (440 lb)

**Seat height** 870 mm (34.2 in)

**Wheelbase** 1493 mm (58,8 in)

**Rake** 25°

**Front wheel trail** 104 mm (4.1 in)

**Fuel tank capacity** 14.5 l (3.8 US gal)

**Number of seats** 2

## Standard Equipment

Riding Modes, ABS Bosch Cornering, Ducati Slide by Brake, Ducati Traction Control (DTC) EVO, Ducati Wheelie Control (DWC) EVO, Power Modes, Ride-by-Wire, Day Time Running Light (DRL), Tapered aluminum handlebars, Removable passenger footpegs, USB power socket, Ready for: Anti-theft system, Ducati Quick Shift (DQS) up/down EVO, Heated grips, Ducati Multimedia System (DMS).

## Warranty

24 months unlimited mileage

## Maintenance

**Maintenance service intervals** 15,000 km (9,000 mi)/12 months

## Maintenance

**Valve clearance adjustment** 30,000 km (18,000 mi)

## Emissions & Consumption\*

**Standard** Euro 5

**CO<sub>2</sub> Emissions** 123 g/km

**Consumption** 5,3 l/100 km



Equal to 18,000 miles

Kilometers refer to the first Desmo Service, i.e. when the valve clearance is checked and adjusted if necessary.

\* Only for countries where Euro 5 standard applies.

A 35 kW restricted power version of the Hypermotard 950 is available for restricted license holders. Please contact your dealer for information on availability.

# HYPERMOTARD 950

Bodywork: Ducati Red  
Frame: Ducati Red



# HYPERMOTARD 950 SP

Bodywork: SP Livery  
Frame: Ducati Red



# HYPERMOTARD 950RVE

	Hypermotard 950	Hypermotard 950 RVE
Ducati Quick Shift (DQS) Up/Down EVO	Accessory	Standard
Color	Ducati Red	Graffiti Livery



1 Ducati Quick Shift (DQS) up/down EVO



2 Graffiti Livery

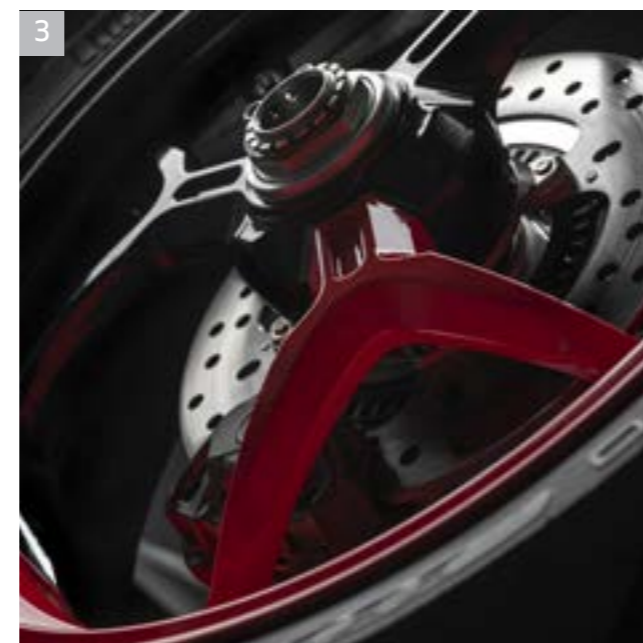

3 Wheels with Ducati Red trim

Bodywork: Graffiti Livery  
Frame: Black



	Hypermotard 950	Hypermotard 950 SP
Front suspension	Ø 45 mm Marzocchi fully adjustable aluminum fork	Ø 48 mm Öhlins fully adjustable fork
Rear suspension	Sachs monoshock adjustable in pre-load and rebound	Öhlins fully adjustable monoshock
Travel suspension front/rear	170 mm / 150 mm	185 mm / 175 mm
Wheels	Y-shape 3-spokes Aluminum alloy casted	W-shapes 3-spokes Marchesini Aluminum forged
Tires	Pirelli Diablo Rosso III	Pirelli Diablo Supercorsa SP
Ducati Quick Shift (DQS) Up/Down EVO	Accessory	Standard
Front mudguard	Plastic	Carbon fiber
Timing belt covers	Plastic	Carbon fiber
Seat height	870 mm (34.2 in)	890 mm (35.0 in)
Dry weight	178 Kg (392 lb)	176 Kg (388 lb)
Kerb weight	200 Kg (440 lb)	198 Kg (436 lb)
Colour	Ducati Red	SP Livery



1 Headlight with Day Time Running Light (DRL)

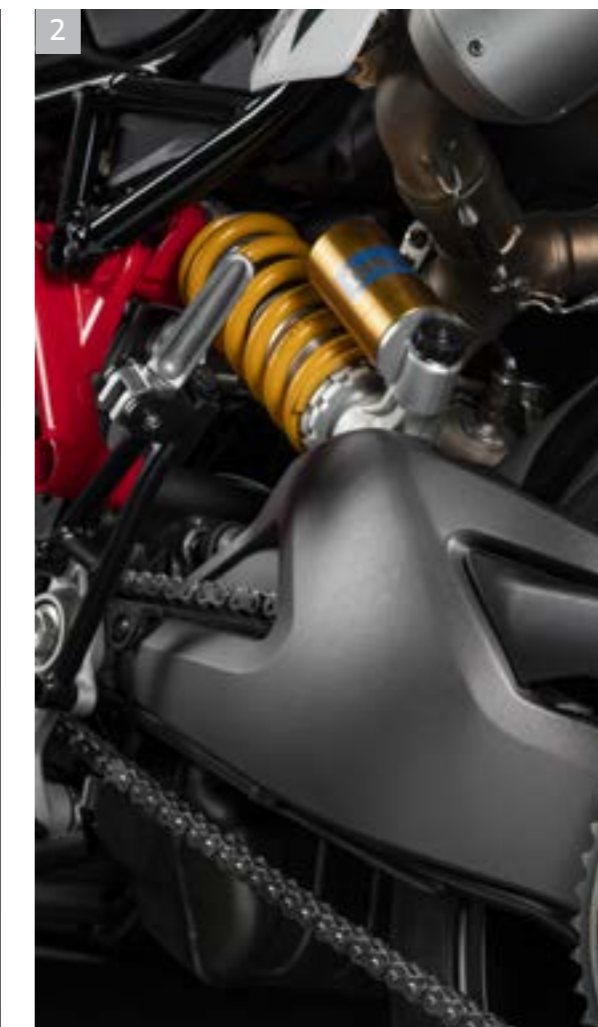

2 Rear Öhlins monoshock



3 Marchesini forged wheels

# Apparel

Ducati Corse C5  
Racing suit

Explorer  
Full-face helmet

Explorer  
Goggles





Ducati Corse C5 Leather gloves  
Race Chair





From top left. DC Track cap. V4 Eyes t-shirt. DC Track sweatshirt. Ducati Corse Sketch t-shirt. DC Track short-sleeved polo shirt. Bottom. Dovizioso sunglasses. DC Track t-shirt.



DC Tonal t-shirt. Acapulco sunglasses.



From left. Dovizioso sunglasses. DC Track t-shirt. Racing Spirit cap. Acapulco sunglasses. DC Tonal t-shirt. Racing Spirit t-shirt.

## ACCESSORIES

# Configure the Ducati of your dreams.

With its aggressive look and fearless, sports nature, the Hypermotard 950 recaptures that original supermoto racing style without losing its sports essence.

### Configure

Choose your ideal Hypermotard 950 and have fun configuring it to suit your riding style!

Share your new Hypermotard with friends or send it to your Ducati dealer who will contact you for an online consultation to discuss the current offers that best suit your needs.

Save your configuration to return to it at any time.

### Calculate your payment

Ducati Financial Services offers favourable solutions for the financing of every model in the Ducati range. Personalise your financing and calculate the monthly instalments. You can then contact your dealer and discuss the best way to see your dream come true!



[Go to configurator](#)

For more information about the Ducati Performance range, tech specs and warnings, refer to a Ducati dealer or visit the Accessories section of website [ducati.com](http://ducati.com)







1 Complete exhaust assembly



2 Carbon heat guard



3 Billet aluminium tank cap



4 Silencers



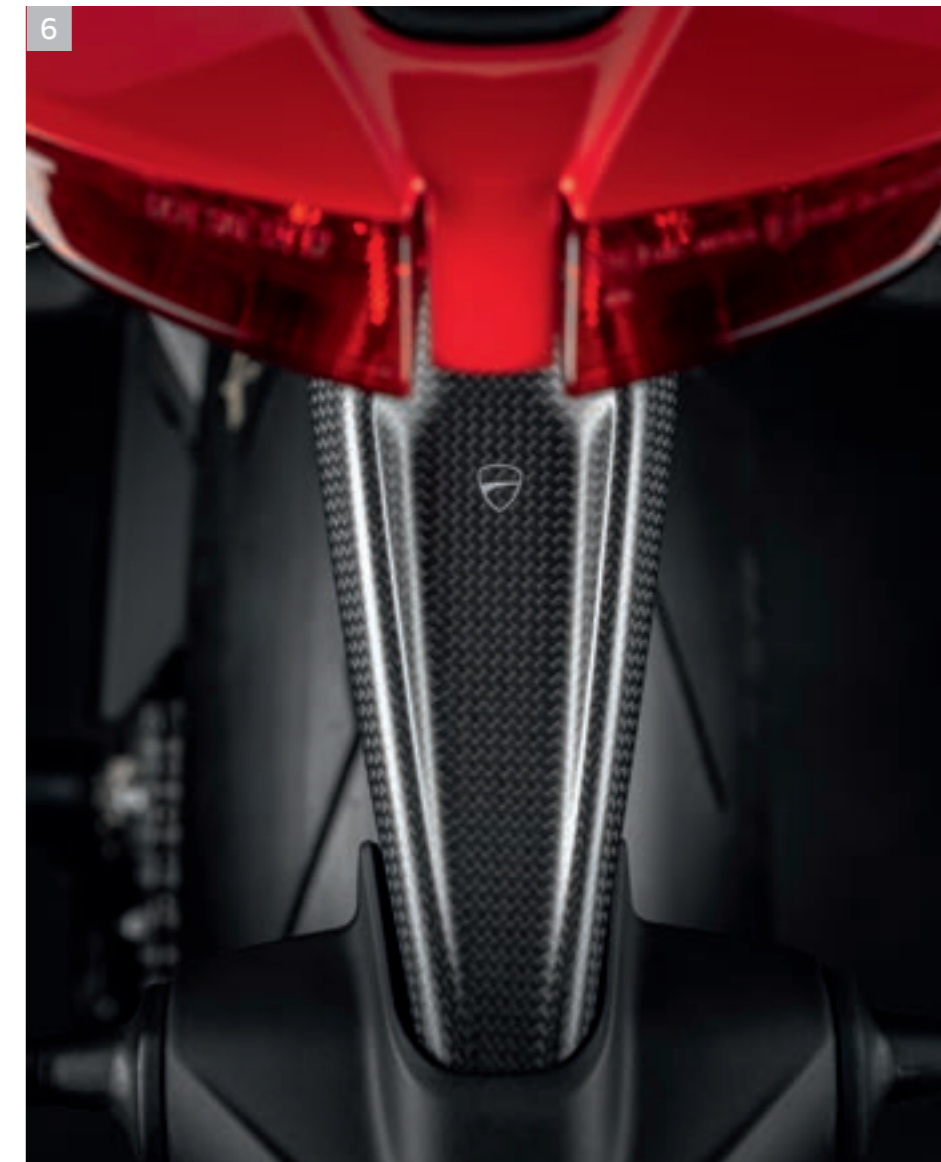

1 LH aluminium rear-view mirror - RH aluminium rear-view mirror ok A

3 Billet aluminium water pump cover A

4 Brake fluid reservoir - Clutch fluid reservoir ■ A

6 Carbon number plate holder support

2 Front fork slider A

5 Carbon rear mudguard

# Ducati Digital Experience

A mission for every channel. Continuous updating about the new products and passion that characterises our work. We turn emotion into exclusive content. Just a click away.

Style, Sophistication, Performance, Trust.  
On the asphalt, as on-line. Follow us on:



@ducati



@DucatiMotor



Ducati Motor Holding



@ducati



Ducati Motor Holding



## Key to simbols

 This product is designed exclusively for race bikes ridden on a closed racetrack. Its use on public roads is forbidden by law.

 For racing use only. The product marked with this symbol can only be used on competition vehicles. Use outside a competition track of motorcycles equipped with this product is prohibited by law. Verify any further restrictions with the relevant race course. Motorcycles equipped with this accessory are prohibited from operating on public roads.

 Anodized

 Red

 Matt

 Black

 Silver

 This accessory is not approved for road circulation.

 Japan.

 Accessory type-approved for road use.

 Type-approved silencer according to Regulation (EU) No. 168/2013 of 15/01/2013

 This Aftermarket Ducati Performance Kit is certified according the California Air Resources Board for use on public highways.



ducati.com

Riding a motorcycle is the most exciting way to enjoy the road, and offering the utmost safety to the motorcyclist is Ducati's commitment. Ducati bikes are increasingly easy to handle, reliable and better equipped to guarantee maximum safety and enhance riding pleasure. Technical clothing is made with more and more advanced materials for adequate protection and increased visibility. The safety of motorcyclists is Ducati's commitment. For more information visit the safety section of the Ducati site ([www.ducati.com](http://www.ducati.com)).

**Warning:** The photos and technical information in this catalogue may refer to prototypes subject to modifications during production and are purely for illustration and reference purposes, and are therefore not binding on Ducati Motor Holding S.p.A. Sole Shareholder Company - Company subject to the direction and coordination of AUDI AG ("Ducati"). Ducati cannot be held responsible for any print and/or translation errors. This catalogue is transnational and therefore some products may not be available and/or their features may vary in accordance with local laws. Not all colours and versions are available in each country. Ducati reserves the right to make changes and improvements to any product without obligation of prior notice or to make such changes to products already sold. Further characteristics of the products are contained in the pertinent owner's manuals. The products represented are not definitive versions and are therefore subject to significant changes at Ducati's discretion without prior notice. The photographs published in this catalogue show only professional riders under controlled street conditions. Do not attempt to imitate such riding behaviour as it could be dangerous for you or other people on the road. This catalogue, including but not limited to the trademarks, logos, texts, images, graphics and table of contents herein, constitute Ducati intellectual property, or in any event Ducati has the right to reproduce it; any reproduction, modification or other whole or partial use of the catalogue or its contents, including publication on the Internet without the prior written consent of Ducati, is prohibited.

Actual fuel consumption may vary based on many factors, including but not limited to riding style, maintenance performed, weather conditions, surface characteristics, tyre pressure, load, weight of the rider and the passenger, accessories.

Ducati indicates the dry weight of the motorcycle excluding battery, lubricants and coolants for liquid-cooled models. The weights in running order are considered with all operating fluids, standard equipment and the fuel tank filled to 90% of its useful capacity (UE regulation no. 168/2013). June 2020.



Developed with



Technical partner

