

XDIAVEL





Index

4	The Power of Opposites	18	Full LED light set with DRL
7	XDiavel Dark, the sleek bike	21	A true Ducati chassis and brakes
8	XDiavel S, the sophisticated bike	24	Servicing and maintenance
11	Maximum control in total comfort	27	Technical data
13	Cruiser according to Ducati	34	Apparel and accessories
14	Powerful and high-performance	36	XDiavel tailor-made
16	Comfort, enjoyment and safety		

The Power of Opposites

XDiavel combines exciting performance, sports power, and advanced electronics with typical cruiser traits, for a long, low and comfortable bike with feet-forward riding position and significant torque already at low rpm. All enhanced with top-of-line materials and finishes.
The Ducati cruiser combines the best of both worlds while staying true to its philosophy.





XDiavel Dark, the sleek bike

The sleek matte black of the XDiavel Dark only emphasises the beauty of the Ducati cruiser's shapes.

Matte black is a colour that is part of Ducati history.

With the XDiavel Dark, the total black livery extends all the way to the mechanics and finishes, enhancing the "Reduce to the Max" Ducati design principle. A gateway to the XDiavel world, the XDiavel Dark represents the family's very purity and simplicity.

The bike represented is for countries where Euro 5 standard applies.





XDiavel S, the sophisticated bike

The XDiavel S is the most classic and iconic version. The unique design of the wheels, the exclusive polished black tank, the seat with bi-material upholstery, the natural, brushed swingarm with anodised finish, as well as the many visible machined aluminium details, all contribute to making the XDiavel S so unique. The engine is the undisputed star, thanks to its polished black finish and aluminium belt covers with machined profiles.

The bike represented is for countries where Euro 5 standard applies.



ERGONOMICS

Maximum control in total comfort

The XDiavel offers a relaxed riding position with a low seat and forward controls. A real cruiser. The many adjustments that can then be made to this base, as well as an extensive accessories catalogue, allow every rider to adapt the bike to their own particular style and physical characteristics. Because every Ducati, even a cruiser, puts the rider front and centre.

Footpeg position



The front position footpegs (1) can be adjusted according to three positions, as standard. Thanks to their specific anchoring system, they can be moved 22.5 mm forward or back with respect to the standard position. In addition, a central peg kit (2) and a rear position peg kit (3) are available, both of which can be adjusted according to various positions. The standard handlebar and seat can be replaced with versions that better suit a rider's tastes and needs. For the XDiavel S and XDiavel Black Star passenger, standard equipment includes a larger, more comfortable seat and a backrest that perfectly integrates with the lines of the bike.



RIDING PLEASURE

Cruiser according to Ducati

You can tell it is a Ducati at the very first corner, in the way that it leans (the result of thorough research into geometries), its technical content, its cutting-edge electronics package and its high-level performance, all of which guarantee a unique riding experience. At the same time, the wide handlebar and front position pegs allow for a relaxed and comfortable ride at any speed.

The bike represented is for countries where Euro 5 standard applies.



ENGINE

Powerful and high-performance

The Ducati Testastretta DVT 1262 twin delivers a maximum power output of 160 hp* at 9500 rpm and a maximum torque of 13.0* kgm at 5000 rpm, with an increase of 8 hp and 0.2 kgm with respect to the Euro 4 version.

80% of the maximum XDiavel torque is already available at 2100 rpm. This means you can pick up speed without needing to shift down a gear, by gently opening the throttle. Peak torque of 13.0* kgm is reached at 5000 rpm, a relatively low speed for a Ducati twin.

The Testastretta DVT 1262 is the ultimate expression of technology and design. The water pump, for example, positioned inside the V of the cylinders, remains concealed along with the cooling system pipes, thus improving the aesthetic.

* Euro 5 version

The bike represented is for countries where Euro 5 standard applies.

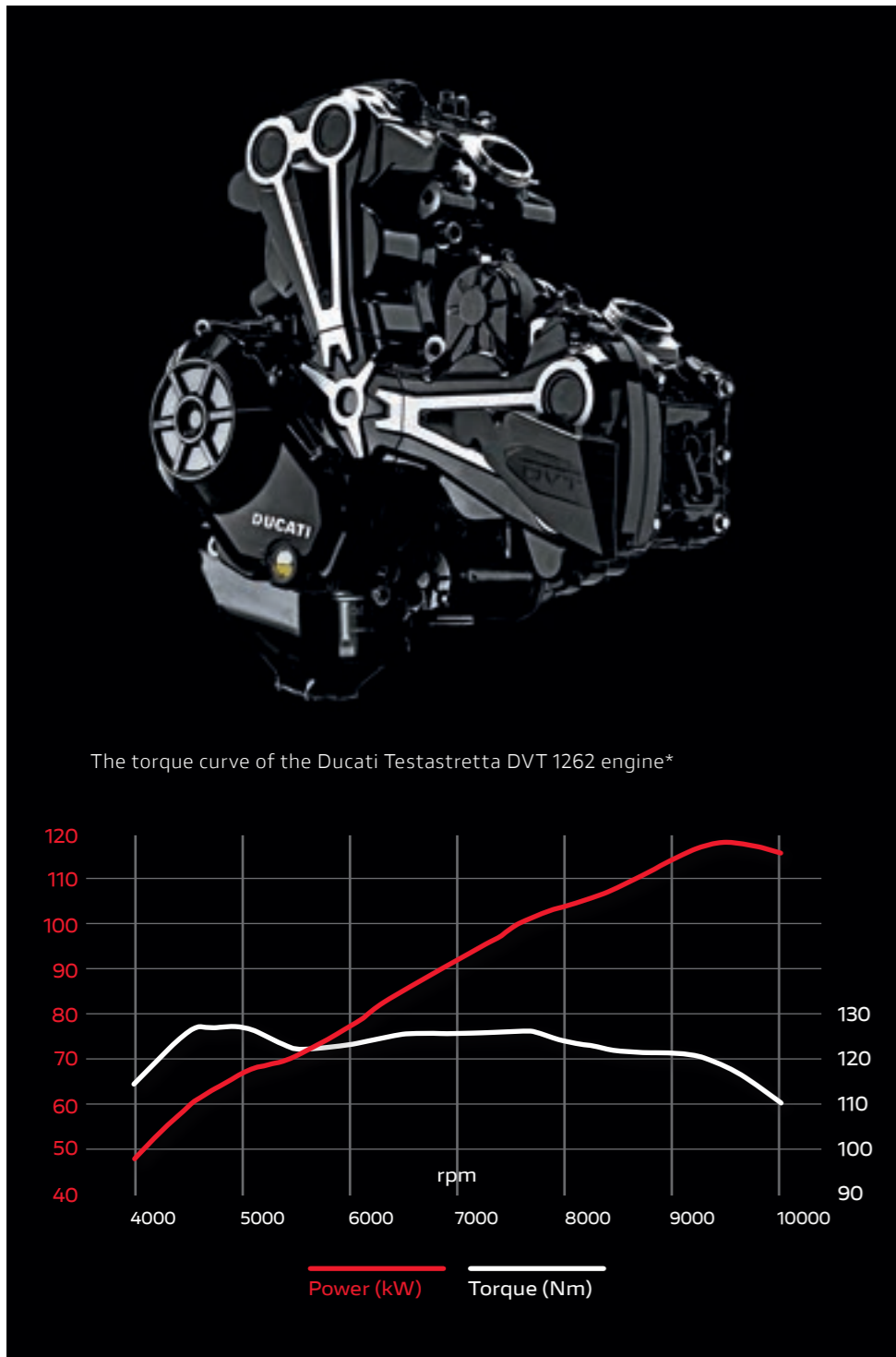

ELECTRONICS

Comfort, enjoyment and safety

The nature of the XDiavel is immediately apparent thanks to its high-level electronics package. The Riding Modes guarantee safety and comfort in all conditions while Power Mode ensures the bike suits every situation.

Latest generation rider assistance systems allow for total control on the road. Cornering ABS makes for very safe braking, even when the bike is at an angle, while Traction Control optimises performance by adapting the control strategy to the rider's particular style and the grip conditions.

The bike represented is for countries where Euro 5 standard applies.



The RbW system uses three different mappings to regulate power delivery: 160 hp with sports delivery (Sport Riding Mode), 160 hp* with progressive delivery suitable for touring (Touring Riding Mode), and 100 hp with progressive delivery for city use (Urban Riding Mode).

But the exuberance of the XDiavel is best expressed with Ducati Power Launch (DPL). This system ensures blistering starts in total safety.

* Euro 5 version

Full LED light set with DRL*

The XDiavel light set is full LED, and includes the turn signals with automatic turn-off function.

The XDiavel S and Black Star are characterised by a front headlight complete with DRL (Daytime Running Light).

The DRL is a particular positioning light that guarantees perfect visibility during the day, its unmistakeable shape also ensuring that the bike is always recognisable.



* Please check with your dealer feature availability.

A true Ducati chassis and brakes

The XDiavel mounts a 50 mm front fork, fully adjustable in terms of its compression, rebound and spring preload (the S and Black Star versions also have DLC coated stems).

The fork has the compression and spring preload register on the left stem, while the rebound register is located on the right stem. With a 30° caster angle and 130 mm trail, the set-up of the XDiavel makes for an agile and controllable front end, which means exceptional handling and a remarkable steering angle.

At the rear, the XDiavel mounts a single shock, adjustable in terms of its spring preload and rebound and equipped with a separate tank.

The high-quality Brembo components, combined with ABS, specific suspension set-up and Pirelli EPT (Enhanced Patch Technology) guarantee the XDiavel outstanding braking performance and maximum safety in all conditions and for riders of any level.



Front position pegs. The front position pegs of the XDiavel can be adjusted according to three positions, as standard. In addition, a central peg kit and a rear position peg kit are available as accessories to guarantee the best ergonomics for every rider.

Trellis frame. The XDiavel frame comprises a steel tube trellis that is connected to the engine heads so that the powertrain becomes a load-bearing element of the chassis.

Belt drive. The XDiavel is the first belt-driven Ducati, a must in the cruiser world. The system was developed for the XDiavel so as to guarantee reliable and safe transmission of the power supplied by the Ducati Testastretta DVT 1262. The advantages of the belt include low noise level, easier cleaning, reduced maintenance, and a smooth throttle response.

Adjustable suspension. At the front, the XDiavel mounts a fully adjustable 50 mm fork with black anodised sleeves and DLC coating (on the S and Black Star versions). At the rear, an adjustable shock

with remote tank is mounted in an almost horizontal position and works together with progressive kinematics. Both the front and rear suspension is designed to ensure comfort, without sacrificing precision and efficiency.

Steel tank. The steel, coverless tank echoes the authentic cruiser world while retaining Ducati DNA with its curvy, muscular shapes.

Single-sided swingarm. The single-sided swingarm of the XDiavel is created by combining three different technologies in the same component. The lower section is fused, while the upper comprises trellis piping and a removable forged element that allows for belt replacement.

Braking system. The XDiavel is equipped with a Brembo braking system with Cornering ABS as standard. Front brake performance is guaranteed by radial-mounted monobloc callipers, activated by a radial master cylinder with integrated tank and two 320 mm semi-floating discs. At the rear, a 265 mm disc is restrained by a two-piston calliper.



Servicing and maintenance

Safety as Standard

Cutting-edge motorcycles and maximum levels of active safety are cornerstones of the Ducati philosophy. This is why designers and engineers work tirelessly to define increasingly advanced rider assistance systems, such as the Ducati Safety Pack (DSP), a package that, for the XDiavel, comprises Cornering ABS and Ducati Traction Control (DTC). This equipment optimises the bike's dynamic behaviour in braking and acceleration and ensures maximum safety in all conditions, thanks to the possibility to adjust ABS and DTC intervention.

More value to your passion

With Ever Red, the quality and reliability of the Ducati brand remain your inseparable travelling companions over time. Ever Red is the exclusive Ducati warranty extension programme. With its activation you can continue to feel protected for 12 or 24 months beyond the expiration of the Ducati Warranty (24 months). Ever Red includes roadside assistance for the entire coverage period and no mileage limits. In this way you can ride for all the kilometres you want, even abroad, enjoying your Ducati without any worries.

To find out if the Ever Red extension is available in your country and for further information contact your Ducati dealer or visit ducati.com

Enjoy the road, with confidence

The XDiavel is also born out of continuous investment in the quality of the design, materials and technologies. All of this ensures that the Testastretta DVT 1262 engine enjoys particularly long maintenance intervals. The use of specific materials for the valve seats, an improvement in combustion efficiency and the containing of operating temperatures mean that the XDiavel boasts maximum reliability and very simple management. Scheduled maintenance is only needed every 15,000 km (9,000 miles), while the Desmo Service, which includes valve clearance adjustment and registration, performed only every 30,000 km (18,000 miles). Hence, the XDiavel allows you to appreciate the low-speed excitement, with confidence.

Always by your side

One of Ducati's main goals is to offer every Ducatista the chance to enjoy unlimited and safe travel all over the world. To achieve this aim, Ducati offers a "fast delivery" original spares service, with delivery in 24/48 hours across 85% of the areas in which it operates. With a distribution network that covers more than 92 countries, thanks to 790 official Dealers and Service Points*, choosing a Ducati means you can travel worry-free and in total freedom, wherever the road may take you, and count on capillary support that ensures Ducati quality and professionalism is always close at hand.

790 Authorised dealers and service points

92 World countries

*information - last update 31 December 2021



Ever Red
Extended Warranty



*Equal to 18,000 miles.



The bike represented is for countries where Euro 5 standard applies.



Technical data

XDIAVEL DARK

Dimensioni

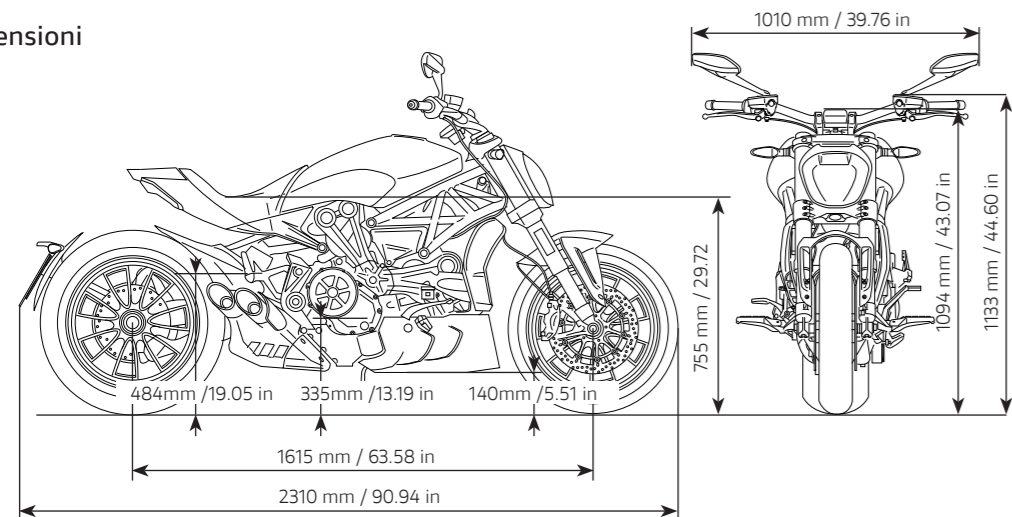

Power / Torque*

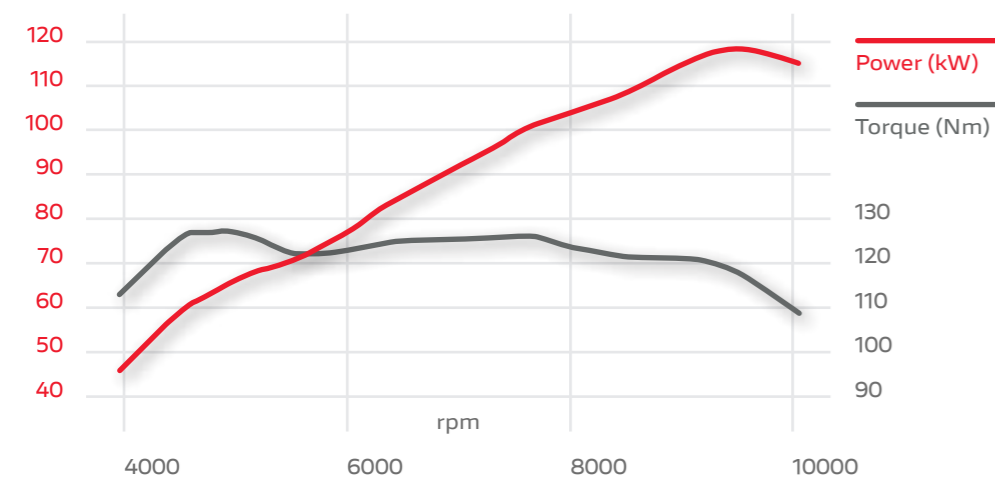

Engine

Engine	Testastretta DVT 1262, V2 - 90°, 4 valves per cylinder, Desmodromic Variable Timing, Dual Spark, liquid cooled
Displacement	1,262 cc (77.0 cu in)
Bore x stroke	106 mm x 71.5 mm
Compression ratio	13.0:1
Power	160 hp (118 kW) @ 9,500 rpm* 152 hp (112 kW) @ 9,500 rpm
Torque	13.0 kgm (127 Nm, 93.7 lb ft) @ 5,000 rpm* 12.8 kgm (126 Nm, 92.9 lb ft) @ 5,000 rpm
Fuel injection	Electronic fuel injection system, Øeq 56 mm elliptical throttle bodies with Ride-by-Wire system
Exhaust	Stainless steel muffler, catalytic converter and 2 lambda probes

Transmission

Gearbox	6 speed
Primary drive	Straight cut gears, ratio 1.84:1
ratio and gear	1=37/15 2=30/17 3=27/20 4=24/22 5=23/24 6=22/25
Final Drive	Belt, front sprocket z28, rear sprocket z80
Clutch	Slipper and self-servo wet multiplate clutch with hydraulic control

Chassis

frame	Tubular steel trellis frame
front suspension	Adjustable Ø 50 mm usd fork
front wheel	Light alloy, cast, 3.5"x17"
front tyre	Pirelli Diablo Rosso III 120/70 ZR17
rear suspension	Preload and rebound adjustable monoshock, remote reservoir, single-sided cast/trellis frame swingarm
rear wheel	Light alloy, cast, 8.0" x 17"
rear tyre	Pirelli Diablo Rosso III 240/45 ZR17
wheel travel (front/rear)	120 mm / 110 mm (4.7 in / 4.3 in)
front brake	2 x Ø 320 mm semifloating discs, radial mounted Brembo monobloc 4-piston M4.32 callipers, PR18/19 radial master cylinder, Cornering ABS
rear brake	Ø 265 mm disc, Brembo 2-piston floating calliper, Cornering ABS
Instrumentation	3.5" TFT colour display and dedicated warning light display

Dimensions and weight

dry weight	221 kg (487 lb)
Kerb weight	247 kg (545 lb)
Seat height	755 mm (29.7 in)
Wheelbase	1,615 mm (63.6 in)
rake	30°
trail	130 mm (5.1 in)
Fuel tank capacity	18 l (4.8 US gal)
Number of seats	2

Safety equipment

Riding Modes, Power Modes, Cornering ABS, Ducati Traction Control, full-LED lighting system**

Standard equipment

Ducati Power Launch, Cruise control, Hands-free, backlit handlebar switches, 3.5" TFT colour display

Warranty and Maintenance

Warranty	24 months, unlimited mileage
Maintenance	15,000 km (9,000 mi) / 12 months
Valve clearance check	30,000 km (18,000 mi)

Emissions and Consumption*

Standard	Euro 5
CO2 Emissions	129 g/km
Consumption	5.5 l/100 km



Equal to 18,000 miles

Indication of mileage at the first Desmo Service, or rather the first service during which valve clearance is checked and adjusted if necessary.

* Only for countries where Euro 5 standard applies.

** Please check with your dealer feature availability.



	XDiavel Dark	XDiavel S
Front suspension	Adjustable Ø 50 mm usd fork	Adjustable Ø 50 mm usd fork with DLC treatment
Wheels	Die-cast in light alloy	Die-cast in light alloy and machined
Front brake	2 x Ø 320 mm semifloating discs, radial mounted Brembo monobloc 4-piston M4.32 callipers, PR18/19 radial master cylinder, Cornering ABS	2 x Ø 320 mm semifloating discs, radial mounted Brembo monobloc 4-piston M50 callipers, PR16/19 radial master cylinder, Cornering ABS
Dry weight	221 kg (487 lb)	223 kg (492 lb)
Kerb weight	247 kg (545 lb)	249 kg (549 lb)
Engine finish	Matte black	Polished black with machined belt covers
Seat	Standard	Dedicated Premium
Rear-view mirrors	In plastic	In billet aluminium
Footpeg support plate and frame plates	Forged	Forged and machined
Headlight	Full LED	Full-LED with Daytime Running Light (DRL)*
Ducati multimedia system (DMS)	Accessory	Standard equipment
Comfort passenger seat and backrest	Unavailable	Provided

* Please check with your dealer feature availability.



1_ Head cover in Ducati Red. 2_ The full LED headlight with DRL system. 3_ Black Star sports livery. 4_ The exclusive design of the XDiavel S rear wheel.

XDIAVEL DARK

Dark Stealth



The bike represented is for countries where Euro 5 standard applies.

XDIAVEL S

Thrilling Black



The bike represented is for countries where Euro 5 standard applies.

Apparel and accessories



1_Black Rider Leather jacket. D-Attitude Full-face helmet. Soul Technical jeans. Soul Leather jacket



2_Company C2 Leather jacket. Merge Open-face. 3_Soul Fabric-leather gloves

XDiavel tailor-made

The cruiser spirit of the XDiavel is expressed to the fullest through the numerous possibilities for customisation offered by its range of accessories. Drawing from the creativity of Roland Sands, American designer and customiser, Ducati Performance has produced a range of unique, elegant and sporty accessories which enhance the exclusivity of the XDiavel.

The ergonomics can also be personalised depending on the needs and tastes of each rider, thanks to seats, handlebars and footpegs. Owing to the exclusive titanium exhaust system created in collaboration with Termignoni, the Testastretta DVT 1262 engine can express its full potential ensuring extremely high performance levels. In addition, the XDiavel's complement of equipment can be further enriched by the Ducati Multimedia System (standard on the S version), which allows you to connect your bike to your smartphone and operate its features using a button on the handlebars, with the related information being displayed directly on the dashboard.

Try the online configurator and customise your new Ducati bike at configurator.ducati.com



1_Timing inspection cover. 



2_“Premium” rider seat.



3



4



5







6

3_ LH aluminium rear-view mirror  4_ Billet aluminium tank cap. 5_ Forged aluminum rims.

6_ Racing silencers. 

Key to symbols

-  This product is designed exclusively for race bikes ridden on a closed racetrack. Its use on public roads is forbidden by law.
-  This accessory is not approved for road circulation.
-  For racing use only. The product marked with this symbol can only be used on competition vehicles. Use outside a competition track of motorcycles equipped with this product is prohibited by law. Verify any further restrictions with the relevant race course. Motorcycles equipped with this accessory are prohibited from operating on public roads.
-  Anodized
-  This accessory is approved for road circulation in Europe.



Riding a motorcycle is the most exciting way to enjoy the road, and offering the utmost safety to the motorcyclist is Ducati's commitment. Ducati bikes are increasingly easy to handle, reliable and better equipped to guarantee maximum safety and enhance riding pleasure. Technical clothing is made with more and more advanced materials for adequate protection and increased visibility. The safety of motorcyclists is Ducati's commitment. For more information visit the safety section of the Ducati site (www.ducati.com).

WARNING: The photos and technical information in this catalogue may refer to prototypes subject to modifications during production and are purely for illustration and reference purposes, and are therefore not binding on Ducati Motor Holding S.p.A. Sole Shareholder Company - Company subject to the direction and coordination of AUDI AG ("Ducati"). Ducati cannot be held responsible for any print and/or translation errors. This catalogue is transnational and therefore some products may not be available and/or their features may vary in accordance with local laws. Not all colours and versions are available in each country. Ducati reserves the right to make changes and improvements to any product without obligation of prior notice or to make such changes to products already sold. Further characteristics of the products

are contained in the pertinent owner's manuals. The products represented are not definitive versions and are therefore subject to significant changes at Ducati's discretion without prior notice. The photographs published in this catalogue show only professional riders under controlled street conditions. Do not attempt to imitate such riding behaviour as it could be dangerous for you or other people on the road. This catalogue, including but not limited to the trademarks, logos, texts, images, graphics and table of contents herein, constitute Ducati intellectual property, or in any event Ducati has the right to reproduce it; any reproduction, modification or other whole or partial use of the catalogue or its contents, including publication on the Internet without the prior written consent of Ducati, is prohibited.

Actual fuel consumption may vary based on many factors, including but not limited to riding style, maintenance performed, weather conditions, surface characteristics, tyre pressure, load, weight of the rider and the passenger, accessories.

Ducati indicates the dry weight of the motorcycle excluding battery, lubricants and coolants for liquid-cooled models. The weights in running order are considered with all operating fluids, standard equipment and the fuel tank filled to 90% of its useful capacity (UE regulation no. 168/2013). For more information visit www.ducati.com.

March 2022



ducati.com

WDW2022
WORLD DUCATI WEEK
22nd - 24th July / Misano, Italy
wdw.ducati.com

Developed with  Shopify

Technical partner 