

# MULTISTRADA V4

PIKES PEAK







# Index

5	Rule all mountains	26	Servicing and maintenance
6	Sharp, fast, effective. And as powerful as ever.	29	Technical data and equipment
9	170 HP V4 Granturismo engine	34	Apparel
11	Italian Design. Multistrada Style	38	Accessories Configure the Ducati of your dreams.
15	New “Pikes Peak” livery	40	Ducati Digital Experience
16	Chassis. Racing technology, equipment, and aesthetics		
20	Ergonomics. Comfier than a sports bike, sportier than a crossover		
22	Performance-oriented Electronics		





## Rule all mountains

When sportiness is more important to you than anything else.

The Multistrada V4 Pikes Peak was developed to bring the sporty qualities of the Multistrada V4 S to the extreme: a dedicated riding position, 17" wheels with sports tyres, single-sided swingarm, Öhlins electronic suspension and the new Race Riding Mode. A bike that is sharp, precise and effective even on the track.

The Multistrada V4 Pikes Peak is not only the sportiest Multistrada ever, it is also the most powerful model in the entire crossover segment. Exciting and adrenalin-fuelled, it is powered by the V4 Granturismo engine, capable of delivering 170 hp at 10,500 rpm and guaranteeing high performance in sporty riding thanks to new electronic management strategies.



# Sharp, fast, effective. And as powerful as ever.

Sharp and responsive. Precise and adrenalin-fuelled.

In the new Multistrada Pikes Peak the alchemy between chassis, ergonomic, electronic solutions and high level componentry gives the rider the maximum expression of the racing character of the 170 HP V4 Granturismo.

The Multistrada V4 Pikes Peak is a technologically advanced motorcycle, designed for those who love the thrill of sporty riding, especially on mountainous twisties or between the kerbs of a race track.

Sharp and precise, it surprises with its ease of closing the line right from corner entry, maintained even when the throttle is applied: the bike literally goes where the rider's eyes turn.

Hop on and get a taste of the track experience.





ENGINE

## 170 HP V4 Granturismo engine

Lighter and more powerful than the previous generation of twin-cylinder engines.

With a displacement of 1158 cc, the V4 Granturismo engine ensures top-of-the-segment power and torque levels. The Euro 5-compliant engine delivers 170 hp with a maximum torque of 125 Nm at 8,750 rpm. The sporty attitude is enhanced by a racing strategy for the rev limiter and the quickshifter that allows faster gear shiftings and extremely aggressive downshifts, as well as the implementation of an even more direct throttle response in High Power Mode.







## DESIGN

# Italian Design. Multistrada Style

The Centro Stile Ducati focused its attention to perfectly combine shape and function, with the ultimate goal of providing the rider with ideal ergonomics and thus enhancing the performance attitude of the Multistrada V4 Pikes Peak.

### The form follows the function

The technical and functional elements are thus transformed into design elements. From radars to aerodynamic appendages; from windshield to the dashboard; from the handlebar controls to the compartment on the fuel tank, everything has been perfectly integrated into the design of the bike.









## DESIGN

## New “Pikes Peak” livery

The racing mood of the bike is intensified by the dedicated “Pikes Peak” livery, faithfully inspired both in colours and graphics by that of the Desmosedici GP ‘21; even the number plates on both sides of the fuel tank contribute to highlight the deep link with the world of competition.

### Racing details

To further emphasise its vocation for performance, the Multistrada V4 Pikes Peak mounts a two-tone saddle with “V4” logo, a low dark smoked plexiglas, carbon fibre parts, front beak and mudguard, that enhance the overall look with elements that evoke lightness, resistance, and racing passion.



## CHASSIS

# Racing technology, equipment, and aesthetics

The 17" front wheel combined with the adoption of lightened Marchesini aluminium forged rims results in absolute precision between curves and a high speed when reaching the apex. A revised strategy also in the main dimensions and ergonomic elements such as the footpegs and handlebar, to give the rider a more sporty feeling and is dedicated to dynamic riding on asphalt.



### 17" Marchesini forged aluminum rims

The wheels rims are made of forged aluminium, allowing considerable weight savings on unsprung masses and ensuring a considerable speed of execution and an improvement in the bike's dynamic behaviour.

### Single-sided swingarm and "Pikes Peak" livery

A single-sided swingarm and dedicated livery make for an unmistakable sports look. Number holders on each side of the bike are inspired by the graphics of the Desmosedici GP '21.

### Pirelli Diablo Rosso IV Tyres

The new Pirelli Diablo Rosso IV Tyres (120/70-17 front 190/55-17 rear) support the sportiness of the Multistrada V4 Pikes Peak and confirms its pure-performance-oriented character.





#### Class-leading braking system

The braking system of the new V4 Pikes Peak is at the top of the segment and derives directly from that of the Panigale V4. At the front, the system includes 330 mm diameter discs and Brembo Stylema monobloc calipers, like the Multistrada V4 S, to which are added the pads of the Panigale V4 in order to deliver a real superbike-like braking power. At the rear, the system features a single 265 mm diameter disc with a Brembo floating caliper.

#### Öhlins Smart EC 2.0 suspension

The V4 Pikes Peak is the first Multistrada ever to be equipped with electronic Smart EC 2.0 Öhlins suspension. The Smart EC 2.0 system is the same adopted by both Panigale V4 S and Streetfighter V4 S. It is a particularly advanced system that allows an “event based” adjustment, according to the rider’s riding style. This technology borrowed from Ducati supersport bikes is combined for the first time with Riding Mode Race, which acts on the electronic controls to express the bike’s racing potential to the full.



#### Bike geometry

With 25.75° of rake, 120 mm (4.7 in) trail and a 1,595 mm (62.8 in) wheelbase, the Multistrada V4 Pikes Peak offers the typical riding characteristics of a sports bike, while ensuring an adequate level of comfort, even over long distances.



## ERGONOMICS

# Comfier than a sports bike, sportier than a crossover

### Footpegs

The footpegs are higher (+ 10 mm, 0.4 in) and moved backward (+ 10 mm, 0.4 in) in order to allow a more aggressive and effective riding position.

### Handlebar geometry

The handlebar is narrower, lower and has a less accentuated curve. The ergonomics and the position of the footpegs ensure better control during sports riding while still offering an excellent level of comfort.



### Lowered windshield

In line with the Pikes Peak's tradition, the new Multistrada also adopts a lowered windshield that enhances its sportiness without sacrificing the protection of the rider and passenger alike who, as on any self-respecting sport touring, can tackle even longer journeys.



## ELECTRONICS

# Performance-oriented Electronics

The new electronics features are designed to achieve supersport-level riding. These include the introduction of the Race Riding Mode that acts on the main electronics system to ensure maximum performance.

The various settings are easily managed via the back-lit handlebar controls with joystick and the 6.5" TFT display.

The Multistrada V4 Pikes Peak inherits the sophisticated electronics package of the Multistrada V4 S, and is also available with the Radar trim, complete with Adaptive Cruise Control and Blind Spot Detection as standard.



## Wheelie control

The Wheelie Control strategy is updated with a real focus on road and track performance. In particular, the system is much more precise when instinct takes over, a common occurrence with sports riding.

## ABS Cornering

The Multistrada V4 Pikes Peak incorporates the Brembo braking system that exploits the Bosch ABS 10.3ME system with cornering function. The system is specifically calibrated to enhance the bike's sports characteristics and is adjustable according to three levels.

Cornering ABS at level 2 allows for controlled lift of the rear wheel so as to fully exploit the braking phase, even on track, while at level 1 the ABS acts only on the front wheel.





00'00.00  
Lap 1/10  
Off

Side Stand 0 km/h

RACE

17:42

10 12

N  
Gear

rpm X1000

3 km  
73 km  
0.0 km

Air 32 °C

DQS On  
DTC 2  
ABS 1  
DWC off

Low

DUCATI

MULTISTRADA V4



# Servicing and maintenance

## Safety as standard

The continuous work that Ducati carries out in terms of design, research and development has the specific aim of ensuring bikes are always cutting-edge and offer the ultimate level of active safety. A commitment that means defining increasingly advanced systems that heighten the level of rider control during the most delicate riding phases.

The Multistrada V4 can be fully customised in terms of its suspension, performance, comfort and safety and comes complete with the most advanced rider support systems, or rather Riding Modes, Power Mode, Cornering ABS, Ducati Traction Control, Ducati Wheelie Control, Ducati Cornering Light and Ducati Brake Light.

## Choose your Multistrada and start your adventure!

Ducati offers you a four-year warranty on all models in the MY 2021 Multistrada family. Born to satisfy a thirst for travel - no borders, no compromise - the Multistrada offers the utmost in technology, performance, and design. Characteristics that are combined with rider and passenger comfort to achieve just one goal, namely to cover ever-increasing distances. A warranty made possible thanks to the experience of Ducati and its dealer network. A competent and continuously updated team treats every Ducati bike with the same care provided during its design and assembly in Borgo Panigale, so that all you need think about when riding your Multistrada is the next destination.

To find out whether 4Ever Multistrada is available in your country and to receive more information, contact your Ducati dealer or visit [ducati.com](https://www.ducati.com).

## Endless excitement

In designing each bike, Ducati always sets itself the goal of ensuring maximum reliability while reducing maintenance costs. A commitment that has seen it extend the main service interval to 60,000 km (36,000 miles), during which a valve clearance check and registration is carried out as required. Even the simplest operations, like the Oil Service, are now scheduled at 15,000 km (9,000 miles) or 24 months.

An interval that is unbeatable in the two-wheeled world and that only confirms the very high quality standards Ducati applies to its material selection and R&D processes. Ducati continuously invests in the technical training of its dealers. The specific knowledge of official Ducati Service network members means that all operations needed to keep every Ducati in perfect working order are meticulously carried out. Advanced equipment such as the Ducati Diagnosis System ensures every Ducati will always have the latest software updates so that the electronic systems continue to perform at the highest level.

## Always by your side

One of Ducati's main goals is to offer every Ducatista the chance to enjoy unlimited and safe travel all over the world. To achieve this aim, Ducati offers a "fast delivery" original spares service, with delivery in 24/48 hours across 85% of the areas in which it operates. With a distribution network that covers more than 91 countries, thanks to 738 official Dealers and Service Points\*, choosing a Ducati means you can travel worry free and in total freedom, wherever the road may take you, and count on support from our extensive Dealer network that ensures Ducati quality and professionalism is always close at hand.

**738** Authorised dealers and service points

**91** World countries

\*Information updated as of February 2021



\* Only for countries where 4ever Multistrada warranty applies



\*Equal to 36,000 miles.







## Technical data and equipment



# MULTISTRADA V4

## PIKES PEAK

### Dimensions

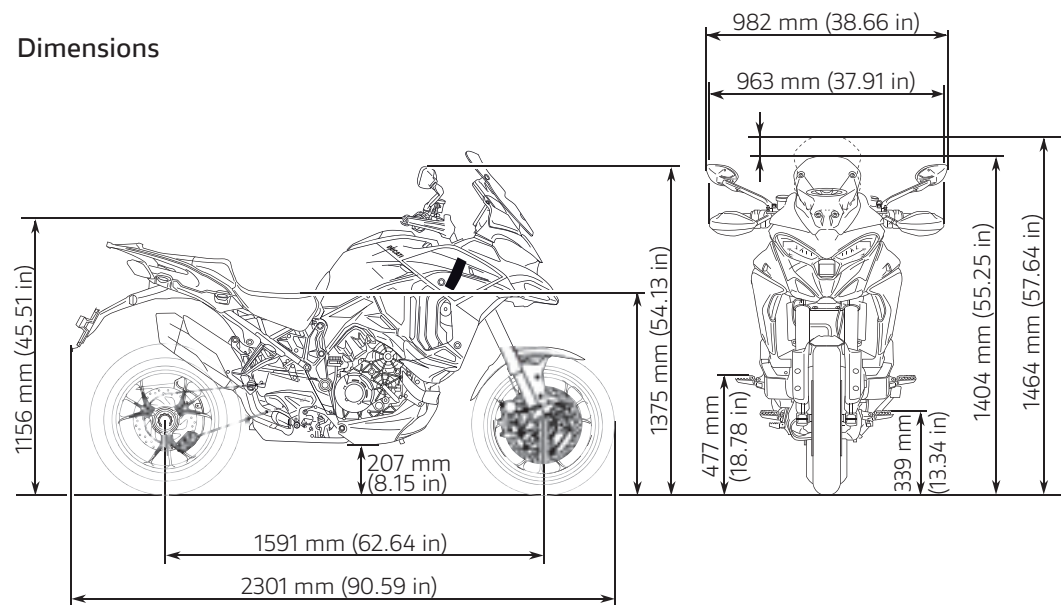

### Power and torque

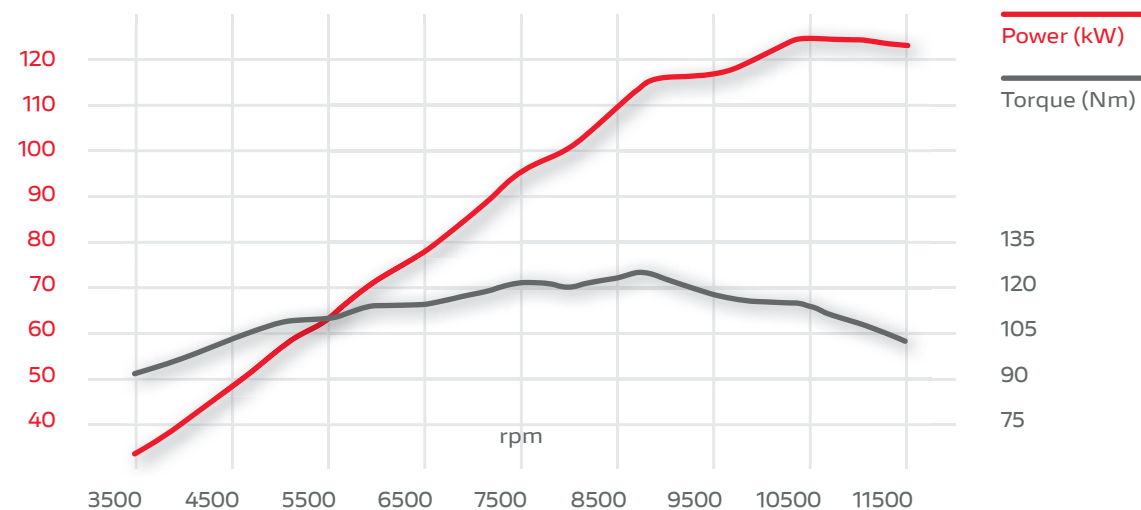

### Engine

<b>Engine</b>	V4 Granturismo, V4 - 90°, 4 valves per cylinder, counter-rotating crankshaft, Twin Pulse firing order, liquid cooled
<b>Displacement</b>	1,158 cc (71 cu in)
<b>Bore X Stroke</b>	83 mm x 53.5 mm
<b>Compression ratio</b>	14.0:1
<b>Power</b>	170 hp (125 kW) @ 10,500 rpm
<b>Torque</b>	12.7 kgm (125 Nm, 92 lb ft) @ 8,750 rpm
<b>Fuel injection</b>	Electronic fuel injection system, Ø <sub>eq</sub> 46 mm elliptical throttle bodies with Ride-by-Wire system
<b>Exhaust</b>	Stainless steel muffler, double catalytic converter and 4 lambda probes

### Transmission

<b>Gearbox</b>	6 speed
<b>Primary drive</b>	Straight cut gears, ratio 1.8:1
<b>Ratio</b>	1=40/13, 2=36/16, 3=34/19, 4=31/21, 5=29/23, 6=27/25
<b>Final drive</b>	Chain, front sprocket z16, rear sprocket z42
<b>Clutch</b>	Multiplate wet clutch with hydraulic control, self-servo action on drive, slipper action on over-run

### Chassis

<b>Frame</b>	Aluminum monocoque frame
<b>Front suspension</b>	Öhlins Ø 48 mm fully adjustable usd fork with TiN treatment, electronic compression and rebound damping adjustment with Öhlins Smart EC 2.0 event-based mode
<b>Front wheel</b>	Marchesini light alloy forged, 3.5" x 17"
<b>Front tyre</b>	Pirelli Diablo Rosso IV 120/70 ZR17
<b>Rear Suspension</b>	Öhlins TTX36 fully adjustable monoshock, electronic compression and rebound damping adjustment with Öhlins Smart EC 2.0 event-based mode, electronic preload adjustment, aluminium single-sided swingarm
<b>Rear wheel</b>	Marchesini light alloy forged, 6" x 17"
<b>Rear tyre</b>	Pirelli Diablo Rosso IV 190/55 ZR17
<b>Wheel travel (front/rear)</b>	170 mm / 170 mm (6.7 in / 6.7 in)
<b>Front brake</b>	2 x Ø 330 mm semi-floating discs, radially mounted Brembo Stylema monobloc 4-piston 2-pad callipers, radial master cylinder, Cornering ABS
<b>Rear brake</b>	Ø 265 mm disc, Brembo 2-piston floating calliper, Cornering ABS

**Instrumentation** 6.5" TFT colour display with Ducati Connect and full-map navigation system

### Dimensions and Weights

<b>Dry weight</b>	214 kg (472 lb)
<b>Kerb weight*</b>	239 kg (527 lb)
<b>Seat height</b>	Adjustable, 840 mm - 860 mm (33.1 in - 33.9 in)
<b>Wheelbase</b>	1,595 mm (62.8 in)
<b>Rake</b>	25,75°
<b>Trail</b>	120 mm (4.7 in)
<b>Fuel tank capacity</b>	22 l (5.8 US gal)
<b>Number of seats</b>	Dual seat

### Safety equipment

Riding Modes, Power Modes, ABS Cornering, Ducati Traction Control, Ducati Wheelie Control, Daytime Running Light, Ducati Cornering Light, Ducati Brake Light, Vehicle Hold Control, Blind Spot Detection

### Standard equipment

Öhlins Smart EC 2.0 electronic suspension, Ducati Quick Shift, Adaptive Cruise Control, Hands-free, Backlit handlebar switches, 6.5" TFT colour display with Ducati Connect and full-map navigation system, Full LED headlight, Carbon fiber front mudguard and beak, Type-approved Akrapovic muffler, Two-tone seat

### Warranty and Maintenance

**Warranty** 24 months (48 months\*), unlimited mileage

**Maintenance** 15,000 km (9,000 miles) / 24 months

**Valve clearance check** 60,000 km (36,000 miles)

### Emissions and Consumption\*\*

**Standard** Euro 5

**CO<sub>2</sub> emissions** 162 g/km

**Consumption** 6.5 l/100 km



Equal to 18,000 miles.

Indication of mileage at the first Desmo Service, or rather the first service during which valve clearance is checked and adjusted if necessary.

\* Only for countries where 4ever Multistrada warranty applies

\*\* Only for countries where Euro 5 standard applies



# MULTISTRADA V4 PIKES PEAK

Pikes Peak livery



1 Low dark-smoked windshield



2 Type-approved Akrapovič exhaust system



3 Electronic Öhlins Smart EC 2.0 suspension



# Apparel

**Ducati Corse V5**  
Full-face helmet

**Ducati Corse C5**  
Racing suit

**Ducati Corse C5**  
Leather gloves

**Ducati Corse V5 Air**  
Racing Boots







**Speed Evo**  
Full-face helmet

**Fighter C1**  
Leather-fabric jacket

**Speed Air C1**  
Leather gloves

**Speed Evo C1 WP**  
Sport-touring boots





ACCESSORIES

# Configure the Ducati of your dreams.

Multistrada means optimum Ducati technology, performance, and comfort. To enjoy adventures and journeys of any distance, in all conditions and on any road.

**Configure**

Choose the ideal Multistrada V2 for you and have fun configuring it to suit your riding style! Share your Multistrada V2 with friends and send it to your Ducati dealer who will contact you for an online consultation to discuss the current offers that best suit your needs.

Save your configuration to return to it at any time.

**Calculate your payment**

Ducati Financial Services offers favourable solutions for the financing of every model in the Ducati range. Personalise your financing and calculate the monthly instalments. You can then contact your dealer and discuss the best way to see your dream come true!



Go to configurator

For more information about the Ducati Performance range, tech specs and instructions, refer to a Ducati dealer or visit the Accessories section of [ducati.com](http://ducati.com)







The racing configuration shown here is intended for use on a closed circuit. Driving on public roads is prohibited by law.





# Ducati Digital Experience

A mission for every channel. Continuous updating on the innovation and passion for which our work stands out. We transform emotions into exclusive content. Just a click away.

## Follow us on:

-  [www.ducati.com](http://www.ducati.com)
-  [@ducati](#)
-  [@DucatiMotor](#)
-  [Ducati Motor Holding](#)

-  [@ducati](#)
-  [Ducati Motor Holding](#)
-  [@ducati\\_official](#)

## MyDucati App

MyDucati is the personal area for every Ducatista, offering a wide range of services accessible with a single login from both the web and the app. Explore all the features of the MyDucati world and enjoy a multi-channel, customised experience wherever you are.

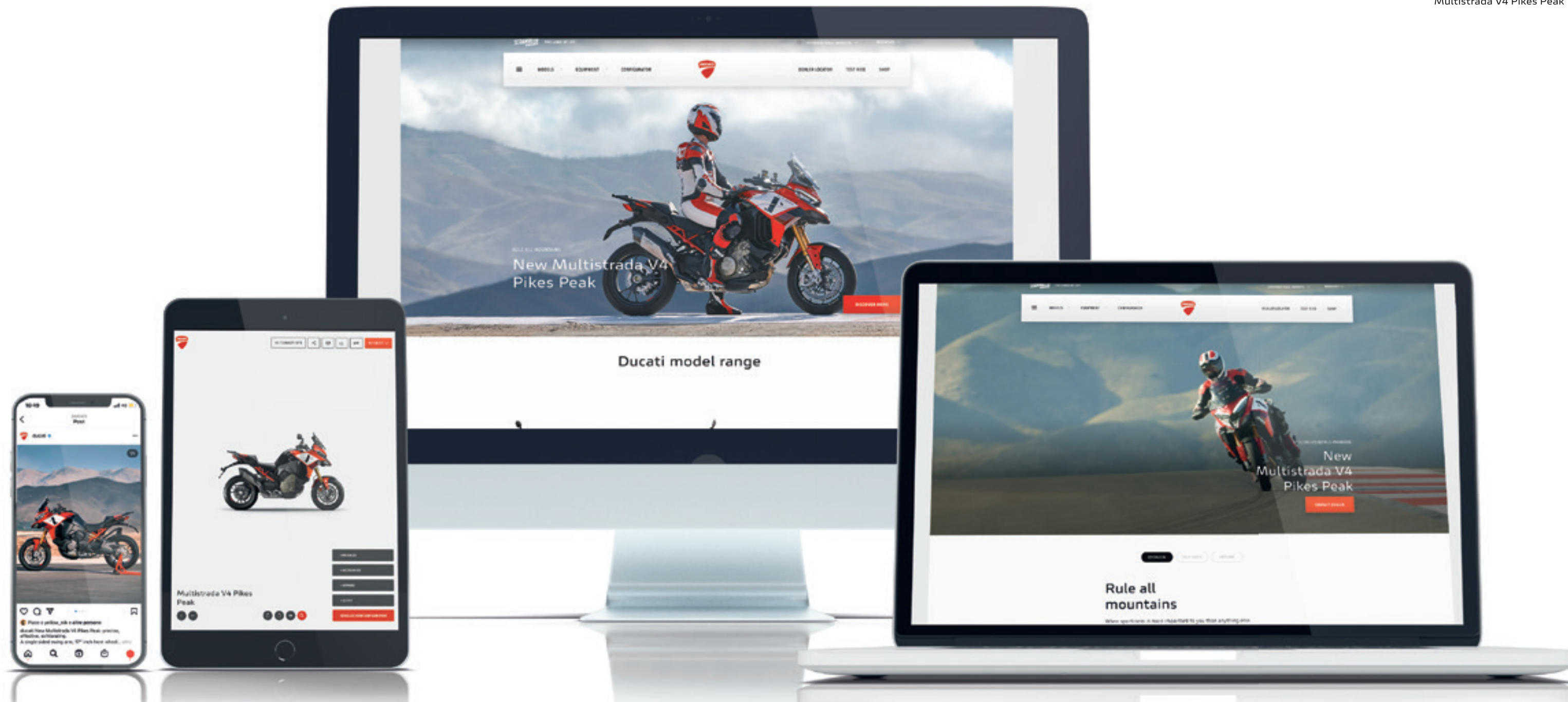



Riding a motorcycle is the most exciting way to enjoy the road, and offering the utmost safety to the motorcyclist is Ducati's commitment. Ducati bikes are increasingly easy to handle, reliable and better equipped to guarantee maximum safety and enhance riding pleasure. Technical clothing is made with more and more advanced materials for adequate protection and increased visibility. The safety of motorcyclists is Ducati's commitment. For more information visit the safety section of the Ducati site ([www.ducati.com](http://www.ducati.com)).

**Warning:** The photos and technical information in this catalogue may refer to prototypes subject to modifications during production and are purely for illustration and reference purposes, and are therefore not binding on Ducati Motor Holding S.p.A. Sole Shareholder Company - Company subject to the direction and coordination of AUDI AG ("Ducati"). Ducati cannot be held responsible for any print and/or translation errors. This catalogue is transnational and therefore some products may not be available and/or their features may vary in accordance with local laws. Not all colours and versions are available in each country. Ducati reserves the right to make changes and improvements to any product without obligation of prior notice or to make such changes to products already sold. Further characteristics of the products are contained in the pertinent owner's manuals. The



[ducati.com](http://ducati.com)



products represented are not definitive versions and are therefore subject to significant changes at Ducati's discretion without prior notice. The photographs published in this catalogue show only professional riders under controlled street conditions. Do not attempt to imitate such riding behaviour as it could be dangerous for you or other people on the road. This catalogue, including but not limited to the trademarks, logos, texts, images, graphics and table of contents herein, constitute Ducati intellectual property, or in any event Ducati has the right to reproduce it; any reproduction, modification or other whole or partial use of the catalogue or its contents, including publication on the Internet without the prior written consent of Ducati, is prohibited.

Actual fuel consumption may vary based on many factors, including but not limited to riding style, maintenance performed, weather conditions, surface characteristics, tyre pressure, load, weight of the rider and the passenger, accessories.

Ducati indicates the dry weight of the motorcycle excluding battery, lubricants and coolants for liquid-cooled models. The weights in running order are considered with all operating fluids, standard equipment and the fuel tank filled to 90% of its useful capacity (UE regulation no. 168/2013). For more information visit [www.ducati.com](http://www.ducati.com).

December 2021



Developed with 

Technical partner 

Technical partner